

# *User's Manual*

(English version)

**ZM-RWB1**

## **VGA RAM WATER BLOCK** **for Higher Water Cooling Performance**

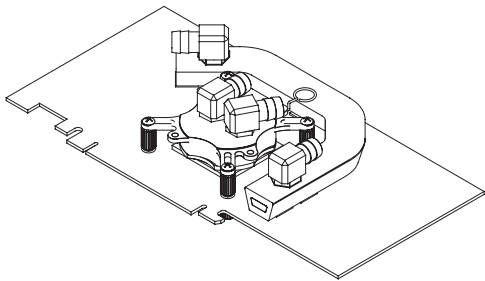

Please visit our website [www.zalman.co.kr](http://www.zalman.co.kr) and watch the ZM-RWB1 installation video for easy installation.

- ※ Please read this manual thoroughly before installation.
- ※ The specifications of this product and its components may change without prior notice to improve performance.

<http://www.zalman.co.kr> <http://www.zalmanusa.com>

## Precautions

- 1) Test the product for leakage outside and away from the system before installing it on the system.  
After confirming no leakage, proceed with installation and use.
- 2) Use approved coolant mixed with distilled water or refined water to prevent corrosion.
- 3) Use coolant tubes listed under the compatibility list.
- 4) Compatible with Geforce 7800/7900 series and ATI 1800/1900 series.
- 5) If interference with components of the VGA card is encountered, then do not install this product.
- 6) Familiarize yourself with this manual.
- 7) Use of an exhaust fan for the back of the case is recommended for enhancing product performance.
- 8) For past GWB3 users, coolant must be completely drained, and the GWB3 must first be removed and be reinstalled.

## Disclaimer

Zalman Tech Co., Ltd. is not responsible for any damages due to external causes, including but not limited to, improper use, problems with electrical power, accident, neglect, alteration, repair, improper installation, or improper testing.

## 1. Features

- 1) Zalman's innovative manufacturing technology provides lightness in weight and excellent cooling performance.
- 2) Pure aluminum-base material water block provides excellent heat transfer, and anodized base prevents corrosion.
- 3) New mounting structure allows easy installation and wide compatibility range.

## 2. Specifications

- 1) Weight : 100g
- 2) Material : Pure aluminum
- 3) Dimensions : 19(W) X 122(L) X 12(H)mm
- 4) Compatible Tubes (Outer x Inner) : 13 x 9mm, 12 x 8mm, 11 x 8mm, 10 x 8mm
- 5) Compatible VGA Cards : Geforce 7800/7900 series and ATI 1800/1900 series

### 3. Components

#### 1) Common Components

- ① One (1) VGA RAM Water Block Assembly
- ② Eight (8) Thermal Tapes
- ③ One (1) Clip
- ④ Two (2) Tube Clamps
- ⑤ One (1) User's Manual

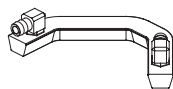

①



②



③



④



⑤

### 4. Exploded View

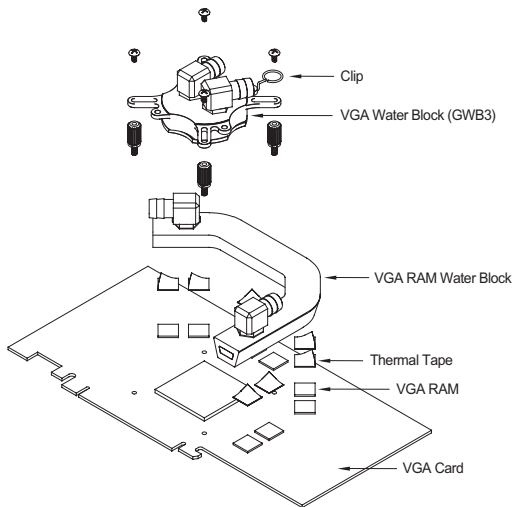

## 5. Installation

### 1) Install VGA RAM Water Block

Place the Thermal Tapes on top of the VGA RAM, remove the film of the Thermal Tapes, and install the ZM-RWB1 on top of these Thermal Tapes by exerting a downward force as shown in the diagram.

**Note 1)** If Thermal Grease or other residue remains on the VGA RAM, then the Thermal Tapes will not stick.

Clean the VGA RAM surface with acetone or alcohol before attaching.

**Note 2)** The bonding strength of the Thermal Tapes reaches 90% after 24 hours of curing. Press down once again after two hours of initial attachment.

**Note 3)** Thermal Tapes are not reusable because they lose adhesiveness after their initial attachment.

Purchase new Thermal Tapes if you need to make reattachments.

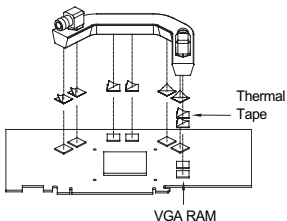

### 2) Attach Clip

Attach the Clip by pushing it up into GWB3's ATI hole as shown in the diagram.

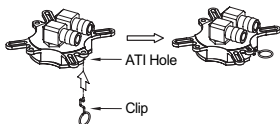

### 3) Connect with GWB3

Install GWB3 with the Clip hooked into the ATI hole as shown in the diagram.

**Note 1)** Hooking the RWB1 Clip into the ATI hole positioned on the upper region of the VGA water block will create tension. Now hook the other side of the RWB1 Clip on to the upper part of the RWB1 in order to effectively install the RWB1.

**Note 2)** For more information on GWB3 installation, please visit [www.zalman.co.kr](http://www.zalman.co.kr) to view the installation video.

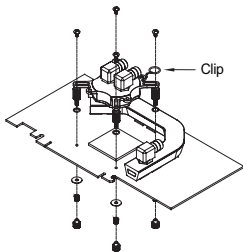

#### 4) Install Tubes

Connect the tubes with the VGA water block and VGA RAM water block's fittings, and install the Tube Clamps.

**Note 1)** Hold the VGA water block and VGA RAM water block with one hand to keep them from moving when installing the tubes.

**Note 2)** Cutting the tubes to adequate length beforehand will simplify the process of connecting the tubes with the VGA water block and RWB1.

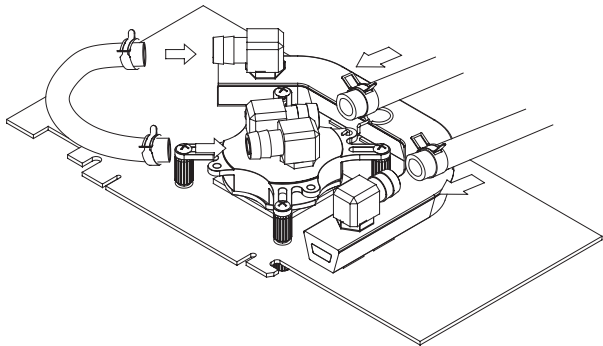

#### 5) Check Installation

Connect the tubes to the VGA water block and VGA RAM water block's fittings as shown in the diagram, and install the Tube Clamps.

**Note 1)** Check to see if the tubes are connected as shown in the picture on the right, and check if the tubes are properly connected by pulling on them.

**Note 2)** After confirming connection, press onto the VGA RAM water block one more time after two hours, check for leakage, and start the system.

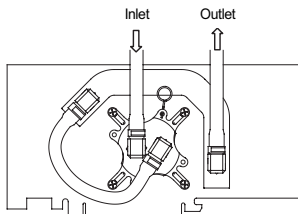

## Zalman Noise Prevention System

Stable performance and noiseless liquid cooling system can both be achieved with the use of Zalman's Noiseless Power Supply, Heatpipe Hard Disk Cooler, Noiseless Case Fan and Northbridge Water Block.



Noiseless Power Supply



Heatpipe HDD Cooler



Noiseless Case Fan



Northbridge Water Block

## TNN(Totally No Noise) Computer Case



**TNN 300**



**TNN 500AF**

TNN Computer Enclosures are the world's first environment-friendly noiseless computer enclosures that operate without the use of a fan. TNN Computer Enclosures use the aluminum enclosure itself as a heatsink. They are ideal for environments that require silence, as well as for home theatre systems and multi-media systems.

## Home Theatre PC Enclosures



**HD160**

The HD160 is designed for ultra quiet home theatre PC operation, utilizing optimized ventilation and anti-vibration reinforcements, making it ideal for environments that require silence such as living rooms, bedrooms, educational facilities, and offices.

For more information, please visit our website.



Disposal of Old Electrical & Electronic Equipment  
(Applicable in the European Union and other European countries with separate collection systems)